

QBRYTE Kabelzuil-mini, montage Bachmann Step

1

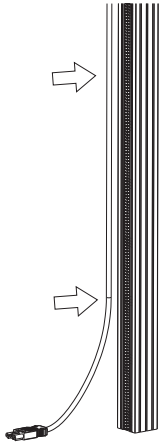

Plaats eerst alle kabels in de kabelzuil

2

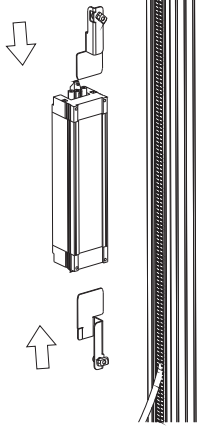

Schuif de montage beugels aan beide zijden op de Step

3

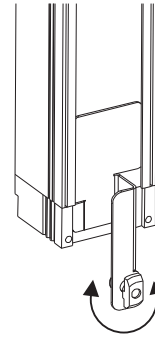

Zorg dat de moeren verticaal staan

4

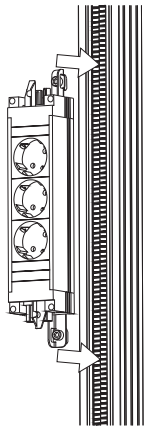

Schuif de montagebeugels in de kabelzuil

5

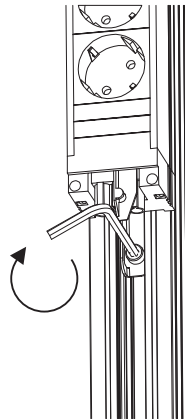

Draai de beide bouten aan zodat de moer kantelt in de gleuf

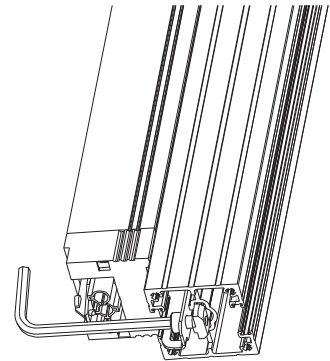

6

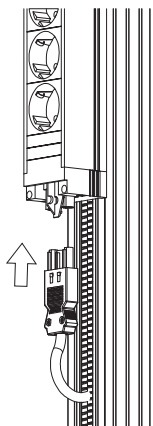

Sluit het snoer aan

7

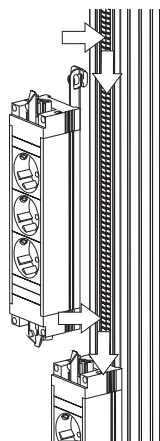

Plaats de bovenste montagebeugel en klik de Step vast op de reeds geplaatste

8

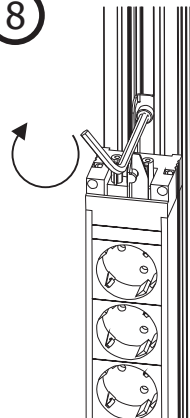

Draai de bout aan

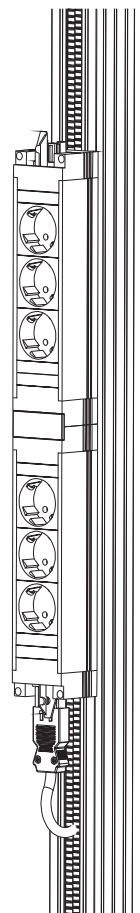

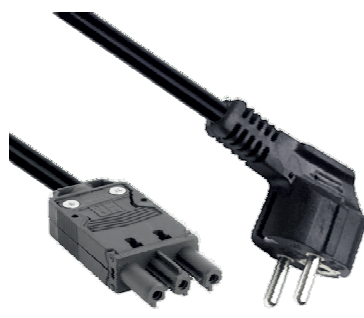

female Schuko
aansluitingen voor een
Schuko - GST18 kabel

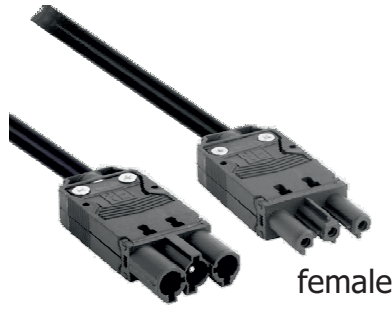

male female
aansluitingen voor een
GST18 - GST18 kabel

Om te zorgen dat de kabel goed in de kabelzuil zit, raden wij aan om deze 'onderlangs' aan te sluiten



Schuko of GST18-male

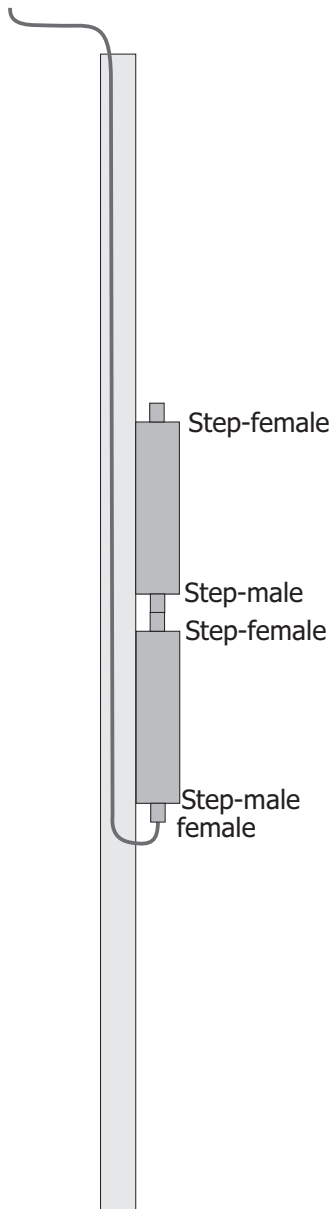

Schuko of GST18-male

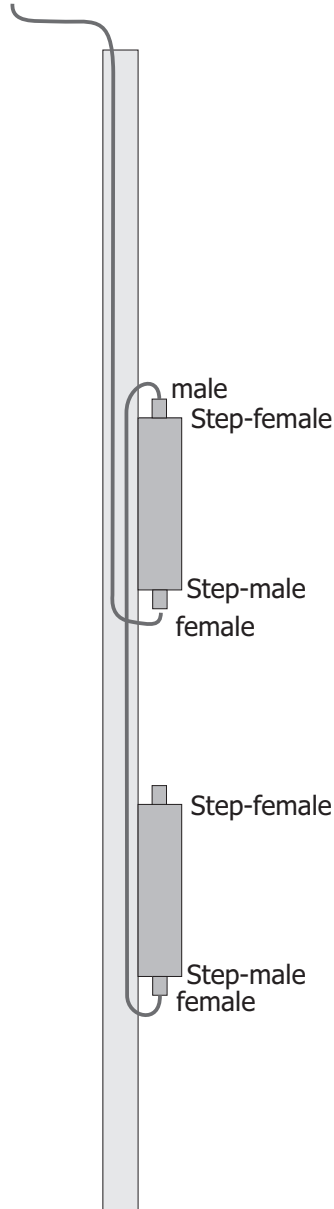

Schuko of GST18-male

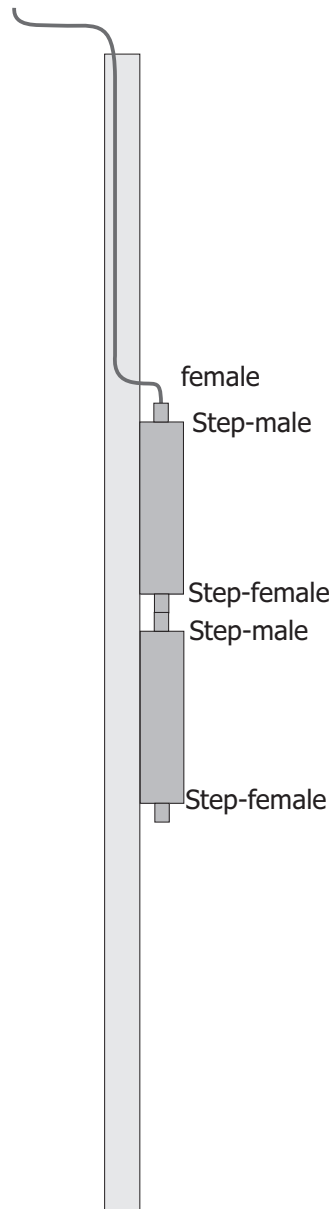

Schuko of GST18-male

